

**NEW**

YOKOGAWA 

# Process Multimeter

CA450

## Loop Power and 4 to 20 mA Output function in a DMM

From daily inspection to troubleshooting of measurement instruments—  
all in a single unit!

### Features

#### ■ Loop check functions

- Simultaneous 24 V loop power and mA measurement
- HART/BRAIN mode setting with loop power (Adds 250 ohm resistance internally)

#### ■ Generation functions

- SIMULATE (SINK) function simulates transmitters
- 4-20 mA span/step/auto-step/sweep output

#### ■ Measurement functions

- High accuracy signal measurement: DC mA 0.05%/30,000 mA
- Handheld DMM function
- Peak Hold function for the peak voltage measurement of DCS power supply
- Dedicated sensor modes for direct reading of many sensor signal types

#### ■ Enhanced Safety—helps eliminate electric shocks

- Current terminal shutter prevents incorrect connections
- 1 A or more of AC/DC current can be read directly using the optional clamp probe and scaling in SENSOR mode.\*1
- Measurement categories 600 V CAT. IV, 1000 V CAT. III

#### ■ Linking with a PC

- DMM Communication Package can be used to save and manage the measurement data.

\*1: AC/DC 600 mV range only



\* This is a composite picture. The shutter actually opens during current measurement and generation.

 3-Year Warranty 

Yokogawa Meters & Instruments Corporation

Bulletin CA450-E

# CA450

Process Multimeter

The CA450 can be used in a wide range of applications, such as checking the operation of field devices and maintenance of electrical equipment.

## Transmitter application

### Loop check function

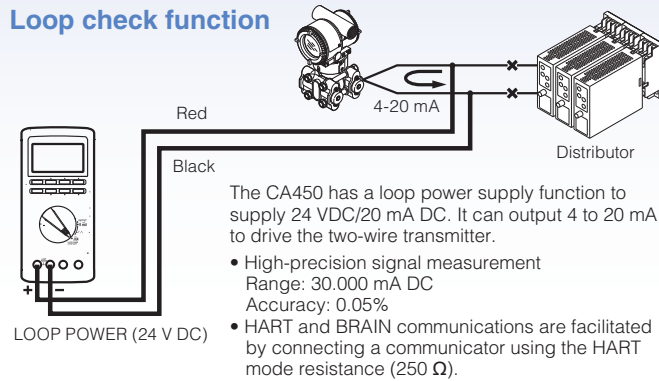

### Transmitter simulation function

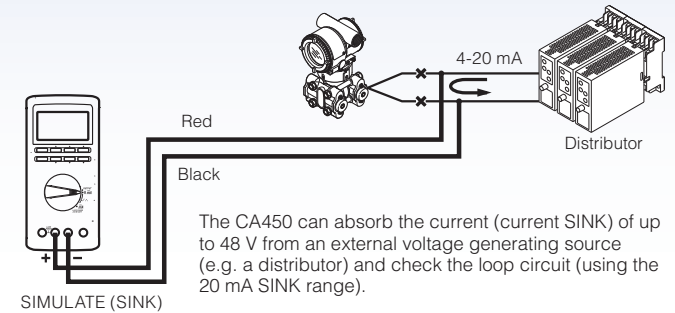

## Valve/Positioner application

### Span generation function

The span from 0 to 20mA or 4 to 20 mA (0 to 100%) can be switched with one touch. It is easy to adjust the span of the valve and check the operation of the valve.

### Step generation function

The step can be generated by increasing or decreasing the step between 0 and 20 mA or between 4 and 20 mA in increments of 25% up to 100% with one touch, or stepwise automatically (step width is selectable) to improve work efficiency. The Slow mode of Step Mode can also be used to change the step time in accordance with the performance of field devices.

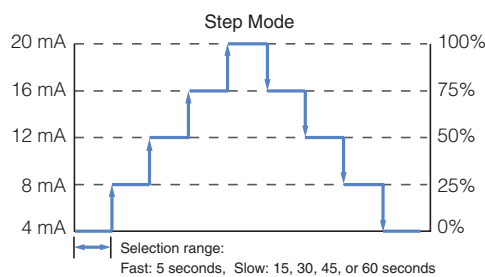

### Sweep generation function

This function is used to increase or decrease the output value to the setpoint at the specified ramp rate. It is possible to switch between Fast (15 sec) and Slow (40 sec) increase or decrease.

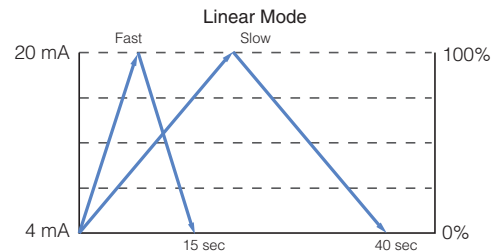

When checking the open-close position of valve and positioner and adjusting it the CA450 supports your maintenance work efficiently

The step generation function is suitable for performing a step response test. The span check mode function enables switching of 4mA (0%) and 20mA(100%) with one key so that it can easily perform zero and span adjustment.

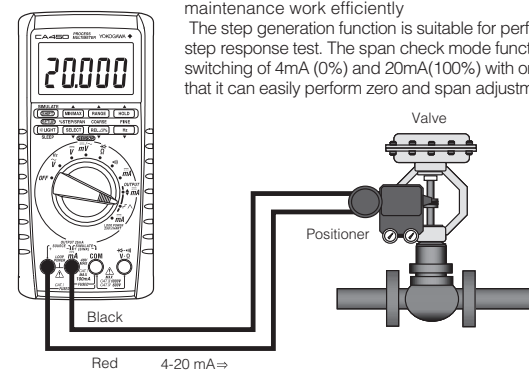

## Electrical equipment check

### AC/DC Current measurement (SENSOR mode)

The CA450 can directly read the various sensor output signals (mV DC/AC) at any scaling. The units can be changed (16 units are available).

Output signal and scaled value are simultaneously displayed.

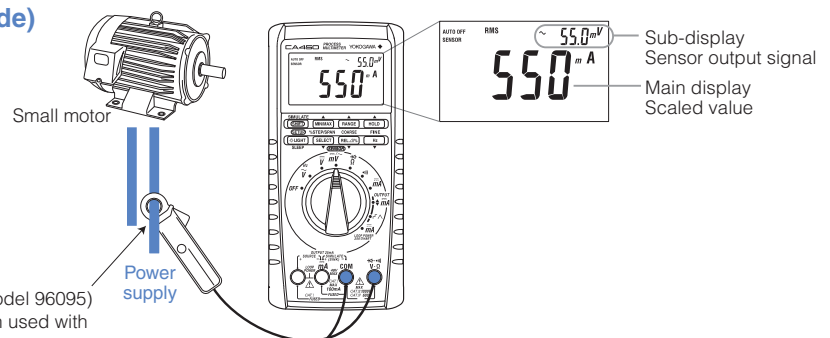

AC/DC clamp-on probe (Model 96095)  
Reads maximum 60 A when used with the CA450.

# Accuracy

Accuracy: ± (% of reading + digits) at 23°C ± 5°C, 80% RH or less

## DC Voltage Measurement $\approx V, \approx mV$

Range	Resolution	Accuracy	Input Resistance	Maximum Input Voltage
600 mV	0.1 mV	0.09%+2	10 MΩ or more	1000 V DC 1000 Vrms AC
6 V	0.001 V	0.09%+1	Approx. 11 MΩ	
60 V	0.01 V		Approx. 10 MΩ	
600 V	0.1 V			
1000 V	1 V	0.1%+1		

NMRR: 60 dB or more, 50/60 Hz ± 0.1%  
CMRR: 120 dB or more, 50/60 Hz (Rs = 1 kΩ)  
Response time: Within 1 second

## AC Voltage Measurement $\sim V, \sim mV$

AC coupling, rms value detection: sine wave

Range	Resolution	Accuracy			Input Resistance	Maximum Input Voltage
		50/60 Hz	40 Hz to 500 Hz	500 Hz to 1 kHz		
600 mV	0.1 mV	0.5%+5	1%+5	1.5%+5	10 MΩ or more, <200 pF	1000 V DC 1000 Vrms AC
6 V	0.001 V				Approx. 11 MΩ, <50 pF	
60 V	0.01 V				Approx. 10 MΩ, <50 pF	
600 V	0.1 V					
1000 V	1 V					

For a range of 5 to 100%, the accuracy for the 1000 V range is 200 V to 1000 V  
CMRR: 60 dB or more, DC to 60 Hz (Rs = 1 kΩ)  
For nonsinusoidal waveforms whose crest factor is less than 3, add ±(2% of reading + 2% of range) to the accuracy.  
For the 1000 V range, the peak voltage is 1500 V or less  
Response time: Within 2 seconds

## DC Current Measurement $\overline{mA}$

Range	Resolution	Accuracy	Voltage Drop
30 mA	0.001 mA	0.05%+2	<0.3 V
100 mA <sup>*1</sup>	0.01 mA	0.05%+2	<0.8 V

\*1 Only the 30 mA range can be used during LOOP POWER output.  
Response time: Within 1 second

## Resistance Measurement $\Omega$

Range	Resolution	Accuracy	Maximum Measuring Current	Open-Loop Voltage	Input Protective Voltage
600 Ω	0.1 Ω	0.2%+2	<1.2 mA	<3.5 V	1000 Vrms
6 kΩ	0.001 kΩ	0.2%+1 <sup>*1</sup>	<110 μA	<1.3 V	
60 kΩ	0.01 kΩ		<13 μA		
600 kΩ	0.1 kΩ		<1.3 μA		
6 MΩ	0.001 MΩ	0.35%+3	<130 nA		
60 MΩ	0.01 MΩ	1%+2 <sup>*2</sup>			

\*1 The accuracy after ZERO CAL.  
\*2 For 40 MΩ to 60 MΩ, the accuracy is 2% + 2.  
Response time: Within 2 seconds for 600 Ω to 600 kΩ, within 10 seconds for 6 MΩ to 60 MΩ

## Continuity Check $\rightarrow \bullet$

Range	Resolution	Operating Range	Measuring Current	Open-Loop Voltage	Input Protective Voltage
600 Ω	0.1 Ω	The buzzer sounds at resistances lower than 50±30 Ω	<1.2 mA	<3.5 V	1000 Vrms

## Diode Test $\leftarrow \rightarrow$

Range	Resolution	Accuracy	Measuring Current (Vf=0.6 V)	Open-Loop Voltage	Input Protective Voltage
2 V	0.001 V	1%+2	Approx. 0.5 mA	<3.5 V	1000 Vrms

## Frequency Measurement in Hz

AC Coupling

Range	Resolution	Accuracy	Input Voltage Range
10.00 Hz to 199.99 Hz	0.01 Hz	0.005%+1	0.3 to 600 Vrms
90.0 Hz to 1999.9 Hz	0.1 Hz		
0.900 Hz to 19.999 kHz	0.001 kHz		0.4 to 600 Vrms

## Peak Hold (P•H)

Measurement Function	Accuracy	Minimum Detection Width
DCV	±100 digits	>6 ms

## Source

### DC Output $\overline{mA}$

Range	Resolution	Accuracy	Load Condition
20 mA	0.001 mA	0.05% of range	SOURCE 0 to 20 mA Compliance voltage 28 V SIMULATE (SINK) 0 to 20 mA External power supply 15 to 48 V overrange up to 25 mA < 10 mH

### 24 V Loop Power Supply (LOOP POWER)

Range	Load Condition
24 V	24 VDC (typ.), load current 20 mA

# General Specifications

Measurement functions: DC voltage, AC voltage, DC current, resistance, frequency, continuity check, diode test  
Additional functions: Data hold (D•H); auto hold (A•H); peak hold (P•H); auto range (Auto); range hold (Range Hold); maximum, minimum, and average value recording and measurement; zero adjustment (Ω); relative measured value display (RELΔ, REL%); 24 V loop power supply; internal resistor on/off for HART communication  
Output functions: 20 mA DC current for current output SOURCE and current output SIMULATE(SINK)  
Additional functions: Current span switching and current sweep output  
Operation methods: Measurement: ΔΣ modulation  
Output: Multiplicative DA  
Display: 5-digit LCD (7 segment)  
Numeric display

Measurement	Output
DC current: 33000	DC current: 25000
Frequency: 19999	
Other: 6600	

Subdisplay: Displays supplemental information for various functions  
Polarity indicator: Automatic display. Only the minus sign “-” appears.  
Over range indicator “OL”  
Low-battery indicator  $\rightarrow \bullet$  appears when the battery voltage is below the operating voltage.

Measurement cycle: 2.5 to 5 times a second (however, frequency measurement takes place once a second)  
Operating temperature and humidity: -20°C to 55°C (80% RH or less) with no condensation  
Within the range of 40°C to 55°C, the humidity must be 70% RH or less.

Storage temperature and humidity: -40°C to 70°C (70% RH or less) with no condensation

Temperature coefficient (typ.): In the ranges of -20°C to 18°C and 28°C to 55°C, add the accuracy of 23°C ± 5°C × 0.1/°C.

Power supply: Four AA-size alkaline batteries (1.5 V LR6)  
Battery life: When using alkaline batteries  
DC voltage measurement: Approx. 140 hours  
DC current output (SIMULATE): Approx. 140 hours  
DC current output (SOURCE) 12 mA (500 Ω load): Approx. 10 hours

Insulation resistance: 100 MΩ or greater at 1000 VDC  
Withstand voltage: 6.88 kVAC for five seconds (between the input terminals and the case)

External dimensions: Approx. 90 (W) × 192 (H) × 49 (D) mm  
Weight: Approx. 600 g (including the batteries)

Compliant standards: Safety standards: EN61010-1 and EN61010-031  
Measurement Categories:

1000 V CATIII, 600 V CATIV  
For current measurement and output: 48 V max, 100 mA max CAT I

Lead cables (98064): 70 VDC, 100 mA CAT I

Pollution degree 2, indoor use

Vibration: Sweep vibration frequencies 10 Hz to 5 Hz to 10 Hz  
Amplitude 0.15 mm (peak value)  
Duration 30 minutes

Shock: 1 m drop test as defined by the safety standards

Altitude: 2000 m or less

EMC standards: EN61326-1 Class B, EN61326-2-2

EN55011 Class B Group 1

Influence of radiated immunity: In RF electromagnetic fields of 3 V/m

EN61326-1 AC voltage measurement, 600 mV range: 1.5% of range

DC voltage measurement, 600 mV range: 1% of range

DC current measurement, all ranges: 1.5% of range

DC current output: 1.5% of range

EN61326-2-2 AC voltage measurement (6 V range or higher):

Within 5 times the accuracy

DC voltage measurement (6 V range or higher):

Within 5 times the accuracy

Standard accessories: AA-size alkaline batteries 4  
Test leads (98073) 1 set  
Lead cables (98064) 1 set  
Fuses (inside the CA450) 440 mA/1000 V (99042) 2  
User's manual 1  
Blank cover 1

Product Model code

Name	Model	Suffix code	Descriptions
Process Multimeter	CA450	-E	With English Instruction manual

Standard accessories











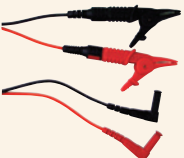

Name	Model	Descriptions
Test leads	98073	1000 V CAT III, 600 V CAT IV Red Black 1 set
Lead cables	98064	Alligator clip, CAT I, for control signal only (under 70 V)
Fuse	99042	440 mA/1000 V 10 A cut off 1 piece

Optional accessories

Name	Model	Suffix code	Descriptions
Carrying Case	93029		For carrying the CA450, the test leads, and the lead cables
Carrying Case	96043	-P1	Carrying case with hanger strap and large size case
Magnet hook	99032		Magnet hook (Maximum weight 1.5 kg)
DMM Communication Package <sup>*1</sup>	92015		USB adapter, USB cable and software
Alligator Test leads	99014		1000 V CAT III, 600 V CAT IV Red Black 1 set
1 to 5 V Adapter Set	99031		250 Ω resistor, terminal adapter and leads
AC/DC Clamp-on Probe	96095		DC180 A, AC130 A, output 10 mV/A
Current Clamp-on Probe	96001		AC400 A, output 10 mV/A

\*1: The application software can use only the measurement function. (Logging function only)

Accessories

 Test leads Model:98073	 Lead Cables Model:98064	 Fuse Model:99042	 DMM Communication Package 92015
 Alligator Test leads Model:99014	 AC/DC Clamp-on Probe Model:96095	 Current Clamp-on Probe Model:96001	 Carrying Case Model:93029
 Magnet hook Model:99032	 The Magnet hook can be attached to magnetic body (e.g. iron).		 Carrying Case Model:93043-P1
			 The inner case with detachable straps can be hung on bar.

Related Products

 CA150	 CA71/CA51	 CA11E	 CA12E
--	--	---	--